

# 4 CH Digital Video Recorder

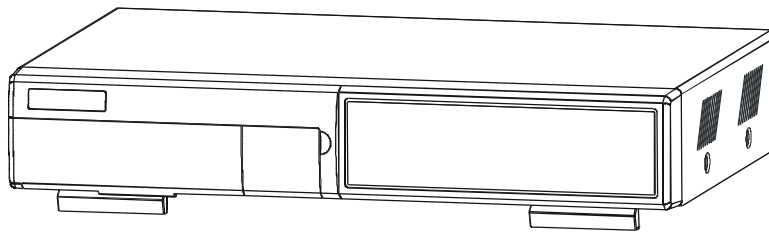

## User's Manual

Please read this instructions thoroughly before operation and keep the manual in a safe place for further reference.

# WARNING

*All the safety and operating instructions should be read before operation. The improper operation may cause permanent damage.*



- This adaptor is only for this machine. Do not use it for other electronic products or it will damage other products.
- Please lift and place this equipment gently.
- Do not expose this equipment to directly sunlight.
- Do not use this equipment near water or in contact with water.
- Do not spill liquid of any kind on the equipment.
- Please power down the unit before unplugging.
- Do not block the ventilation holes at the top and bottom of the unit.
- Do not switch the Power On & Off within short period of time (within 3 seconds).
- Do not attempt to service this equipment by yourself.
- Installation should be made by qualified service personnel.
- Do not try to retrieve the HDD data by PC.



The lightning flash with arrowhead symbol, within an equilateral triangle, is intended to alert the user to the presence of uninsulated "dangerous voltage" within the product's enclosure that may be of sufficient magnitude to constitute a risk of electric shock to persons.



The exclamation point within an equilateral triangle is intended to alert the user to the presence of important operating and maintenance-(servicing) instructions in the literature accompanying the appliance.

# TABLE OF CONTENTS

## What do you get ?

- FEATURES ----- 3
- PACKAGE CONTENT ----- 3

## Before Operation

- INSTALLATION GUIDE ----- 4
- FRONT PANEL ----- 5
- REAR PANEL ----- 7

## Basic Operation

- GETTING STARTED----- 8
- OPERATION----- 8

## Detailed Menu Setup

- MAIN MENU ----- 9
- MENU OPTIONS ----- 9

## Advanced Operation

- OPERATION OPTIONS ----- 16
- KEY LOCK ----- 17
- RS-232 PROTOCOL ----- 17
- TROUBLE SHOOTING----- 17
- SPECIFICATIONS----- 18
- APPENDIX #1 – INSTALL THE HDD ----- 19
- APPENDIX #2 – REPLACE THE HDD ----- 20
- APPENDIX #3 – PIN CONFIGURATIONS ----- 21
- APPENDIX #4 – RECORDING SPEED----- 23
- APPENDIX #5 – NETWORK APPLICATION----- 24

# What do you get ?

## FEATURES

### DVR Features

- Wavelet compression format replaces Time-Lapse VCR + Multiplexer / Quad
- On Screen Display and Remote Control via Video Server & PC
- Picture-in-picture (PIP) and Picture-on-Picture (POP) function in live
- Alarm input & output function
- Video loss detected on each channel
- Multiplexer & Quad recording mode switching
- Recording rate up to full size 30 fields/sec. or Quad size 240 fields/sec.
- Support 1 removable HDD with hot-swap capability, IDE TYPE (over 250 GB)
- Multiple quick search by date/time, alarm, full, list
- Security password protection
- RS-232, RS-485 communication protocol

## PACKAGE CONTENT

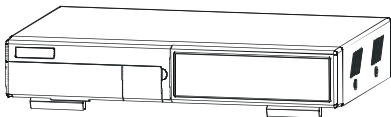

Digital Video Recorder  
(with HDD cartridge)



User Manual



2 Keys



Accessories pack



Accessories pack



Power Adapter and Cord

#### Warning:

1. Please check the package to make sure that you receive the complete accessories which includes the components shown above.
2. This adaptor is suited for DC19V 2A use. If it is damaged, user can find replacement adaptor easily in the locality with this specification.

## INSTALLATION GUIDE

1. Connect cameras and monitor to the DVR.
2. Shown below is an example of connecting the DVR to your existing Observation System.
3. Install HDD (The compatible HDD Brands are listed in the following table.)

Please refer to page 19. Appendix #1 for installation instructions.

\*The HDD must be installed before turning on the DVR. If HDD is not installed, the DVR would function as a 4 CH multiplexer.

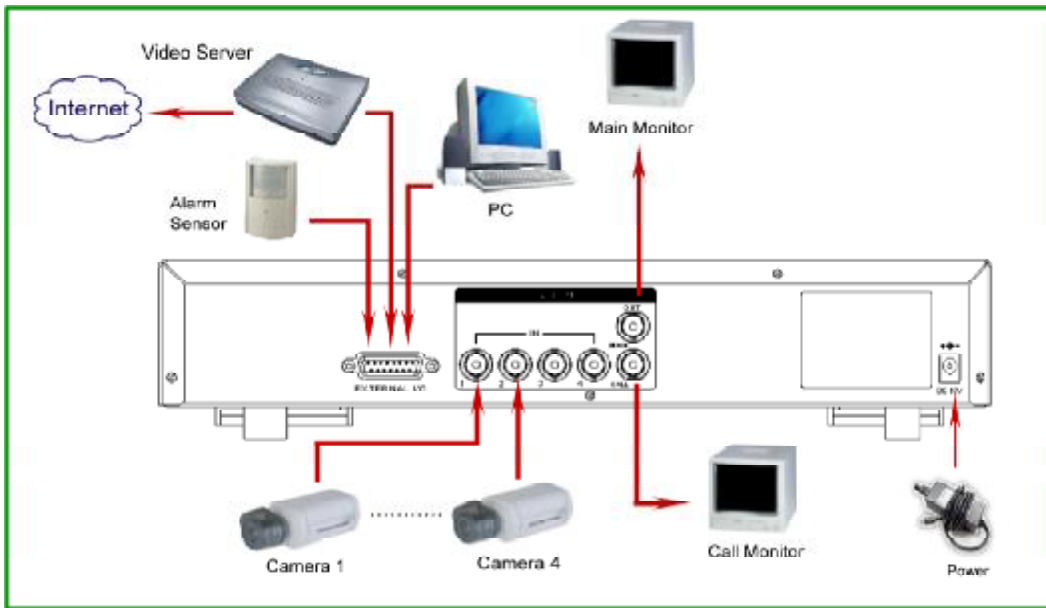







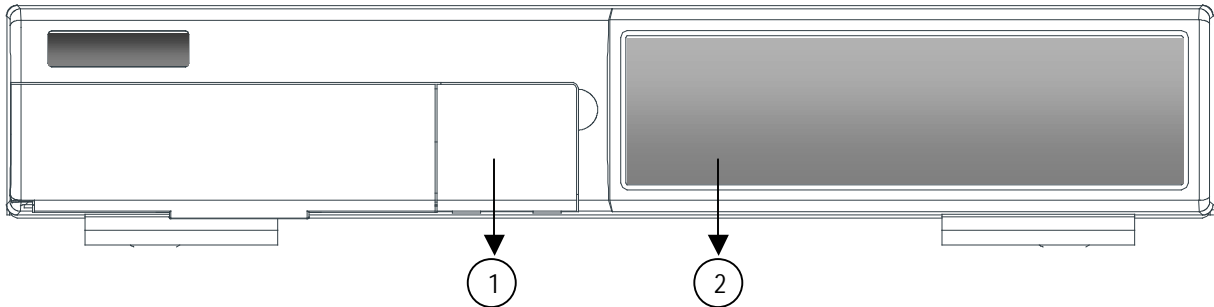

### COMPATIBLE HARD DISK MODELS

Manufacturer	Model	Capacity	Rotation
HITACHI	Deskstar 180 GXP (120 GB)	120GB	7200 rpm
HITACHI	Deskstar 7K250, HDS722516VLAT20	160GB	7200 rpm
HITACHI	Deskstar 7K250, HDS722525VLAT80	250GB	7200 rpm
IBM	Deskstar 120GXP (80GB)	80GB	7200 rpm
IBM	Deskstar 120GXP (120GB)	120GB	7200 rpm
Maxtor	DiamondMax 536DX(60GB) 4W060H4	60GB	5400 rpm
Maxtor	DiamondMax Plus 9	80GB	7200 rpm
Maxtor	DiamondMax Plus 9, Model#6Y120L	120GB	7200 rpm
Maxtor	DiamondMax Plus 9, Model#6Y160L0	160GB	7200 rpm
Maxtor	MaxLine Plus II , Model#7Y250P0	250GB	7200 rpm
Seagate	Barracuda ATA IV, ST380021A	80GB	7200 rpm
Seagate	Barracuda ATA V, ST3120023A	120GB	7200 rpm
Seagate	Barracuda 7200.7 Plus, ST3160023A	160GB	7200 rpm
Western Digital	Caviar WD1200BB-00CAA1	120GB	7200 rpm
Western Digital	Caviar WD2000BB-00DWA0	200GB	7200 rpm
Western Digital	CaviarSE WD2500JB	250GB	7200 rpm

NOTE: For non-stop long-time recording, we suggest to have two HDD for recording to ensure good reliability of HDD.

# FRONT PANEL



1. REMOVABLE HDD CARTRIDGE & KEYHOLE	Please refer to page.19 Appendix #1
2. CONTROL PANEL	
LED LIGHT	<p>The LED Light is ON under following condition.</p> <ul style="list-style-type: none"> <li>• HDD : HDD is reading or recording.</li> <li>• HDD Full : HDD is full</li> <li>• ALARM : To turn off the ALARM LED light, please refer to page.13 &amp; 14 and set the ALARM mode as OFF.</li> <li>• TIMER : When Timer is Enabled</li> <li>• PLAY : Playing mode</li> <li>• REC : Recording mode</li> </ul>
MENU	Press MENU to enter main menu.
ENTER	Press ENTER for confirmation.
SEARCH	Press SEARCH for searching recorded video.
 / POP	Press "  " button for Picture on Picture screen.
 /+ Picture in Picture	<p>PIP: Press "" button for Picture in Picture screen.</p> <p>+ : Press "+" button can change the setting in the menu.</p>
 /- 4 channels display mode	<p>: Press "" button for 4 CH display modes</p> <p>- : Press "-" button can change the setting in the menu.</p>
SLOW	To slow down the speed of playing mode.
POWER	Press Power to turn ON / OFF the DVR.

FF / ►	<ul style="list-style-type: none"> <li>• FF : Play video fast forward. (Press FF button again to adjust speed from 1, 2, 4, 8, 16, 32 times)</li> <li>• ► : Under setup mode, it works as Right button.</li> </ul>
REW / ◀	<ul style="list-style-type: none"> <li>• REW : Play video fast backward. (Press REW button again to adjust speed as 1, 2, 4, 8, 16, 32 times)</li> <li>• ◀ : Under setup mode, it works as Left button.</li> </ul>
STOP / ▼	<ul style="list-style-type: none"> <li>• STOP : Under DVR Record / Play mode, it can stop the action.</li> <li>• ▼ : Under setup mode, it works as Down button.</li> </ul>
PAUSE / ▲	<ul style="list-style-type: none"> <li>• Pause : Under DVR play mode, it can pause the action.</li> <li>• ▲ : Under setup mode, it works as Up button.</li> </ul>
PLAY	Press PLAY to playback recorded video
REC	Press REC to start recording.
CAMERA SELECT (1-4)	Press the Camera Select (1-4) to select the camera.

# REAR PANEL

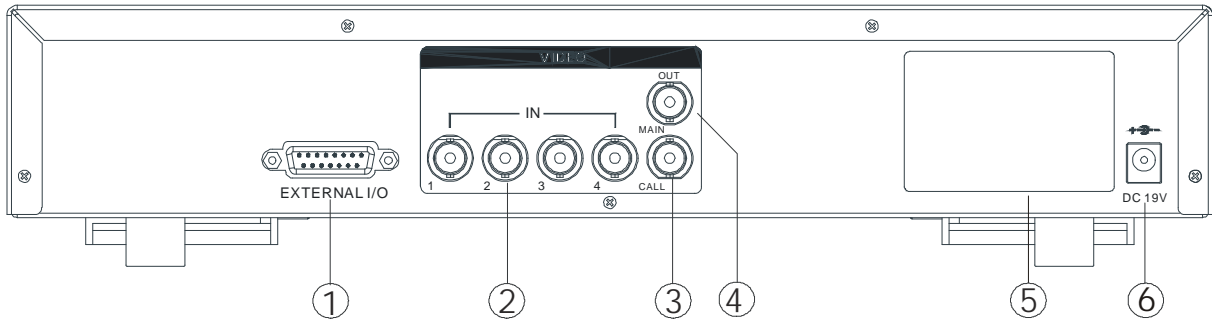

## 1. EXTERNAL I/O

- Controlled remotely by an external device or control system like Video Web Server.
- Alarm input, external I / O expansion.

## 2. VIDEO INPUT (1-4)

Connect to video source, such as camera.

## 3. CALL

Connect to CALL monitor. Show the Switch Display.

When alarm trigger happens, the call monitor will show the triggered channel for a period of time.

## 4. MAIN

Connect to Main monitor.

## 5. FAN (OPTIONAL)

For ventilation.

Note: If the ambient temperature is high or ambient ventilation is bad, we suggest to install a fan on the rear panel.

## 6. POWER

Please use the provided power cord.

Warning:

1. This adaptor is only for this machine. Do not use it for other electronic product or it will damage other products.
2. This adaptor is suited for DC19V 2A use. If it is damaged, user can find replacement adaptor easily in the locality with this specification.

# Basic Operation

## GETTING STARTED

Before using the DVR, please have a HDD installed ready, or it will function as 4 CH multiplexer (refer to Appendix #1 for installation or removal of a HDD).

1. Connect the AC power cord and plug into an electrical outlet. The Red LED indicator light will be ON and the DVR is in Standby mode.
2. Press the Power button. The POWER LED will turn from red to orange, and other red LED indicators will turn ON. It takes approximately 5 to 15 seconds to boot the system with the message : " HDD Detecting ". Once connected, the POWER LED will change to green color, and the Alarm LED will be ON.
3. Before operating the DVR, sets the system time first. (refer to page.10).

NOTE : 1. If the HDD is not installed correctly or not installed, the "HDD not found" message will appear for 3 seconds and then return to 4 CH Multiplexer display mode.

2. To switch the system, you need to turn off the power and pull out the AC power cord, before you reconnect the power, press "POWER" + "FF" to NTSC system or "POWER" + "REW" to PAL system and then reconnect the AC power cord, the DVR will be auto-detecting.

## OPERATION

### RECORDING

The DVR offers 3 recording modes, variety of recording modes. Refer P.23 for advanced setting of recording speed and resolution. Under the recording status, if power is off accidentally, recorded video will still be stored in the HDD. DVR will return to original recording setting after power restores again.

On the screen, you will find the date, time, HDD recording type, the available space of HDD (in GB) left and the symbol "  " represents the recording mode.

(OW : HDD Overwrite)

NOTE : 1. Under O/W Recording mode, previously recorded files will be automatically overwritten without further warning notices, when the HDD is full.

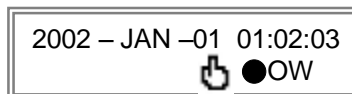

2. If the HDD capacity is only 5 GB left, it will display "5 GB" on the up-right screen and shows orange color, and it will buzz for seconds; so as in 4GB, 3GB, 2GB and 1GB. If the O/W Recording mode (NOTE 1) is on, it won't have the warning buzzer.

There are 3 recording modes: Alarm, Timer, and Manual Recording.

#### 1. ALARM RECORDING

DVR is triggered by an alarm input.  symbol will be shown on the triggered channel. (refer to page13)

#### 2. TIMER RECORDING

Recording is scheduled by a Timer. It will indicate by the symbol  . (refer to page10)

#### 3. MANUAL RECORDING

Recording is initiated manually by pressing the REC button. Symbol  will be shown.

## MAIN MENU

There are 11 options available in the Main Menu:

TIMER ----- Program Timer Recording  
CAMERA ----- Camera Setup  
RECORD ----- Recording Mode Setup  
ALARM ----- Alarm Setup  
DWELL ----- Dwell time Setup  
PIP ----- Picture in Picture Setup  
DISPLAY ----- Display Mode Setup  
REMOTE ----- Remote Control Setup  
USER ----- User Password Setup  
SYSTEM ----- System Setup  
EVENT ----- Event List

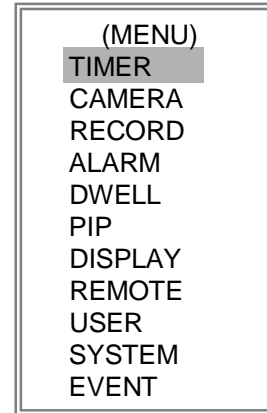

Outlined below are the buttons used for Menu setting :

- “▲” and “▼” : Scroll up and down within a menu option.
- “◀” and “▶” : Scroll sideways within a menu option that has been selected
- “+” and “-” : Increase and decrease the number or change values when an option is selected and is blinking
- ENTER : Select a submenu / an option under a submenu for browsing / modification
- MENU : Complete modification of a menu option; exit a menu

## MENU OPTIONS

### SYSTEM

#### 1. BUZZER

Set the BUZZER “ON”, it will buzzer by event occurrence when the setting is ON.

#### 2. EXT ALARM

To set the EXT ALARM. It will be triggered by event occurrence when the setting is ON.

#### 3. VLOSS ALARM

To set the VLOSS ALARM. When the setting is “ON”, the alarm will start by the setting of Buzzer, EXT alarm or Alarm Duration.

#### 4. KEY MUTE

To set the KEY MUTE. When the setting is “YES”, there will be no sound when you press any key.

#### 5. HDD OVERWRITE

To set the HDD OVERWRITE. When the HDD is full under O/W recording mode, previously Recorded files will be overwritten without further warning notices if the HDD OVERWRITE is ON.

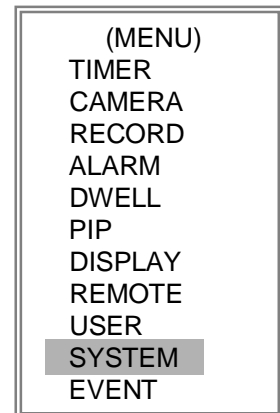

## 6. MESSAGE LATCH

To select whether the DVR messages will disappear after 10 seconds or remain on screen. NO is the default setting which the messages will disappear after 10 sec.

NOTE : Video loss, and Alarm messages will be shown the same as Alarm Duration time.

## 7. DATE DISPLAY

To set the date Y/M/D, M/D/Y, D/M/Y and OFF on monitor or not.

## 8. DATE

To set the date on the DVR.

## 9. TIME

To set the time on the DVR.

## 10. CLEAR HDD

Delete all the contents of the HDD. When you choose "YES" on this option, press "ENTER" and you will be prompted with the question shown: Press "→" to clear HDD or press "←" to cancel.

## 11. SYSTEM RESET

Reset all system settings back to factory default settings. Select "YES" and press "ENTER" button.

(SYSTEM)	
BUZZER	ON
EXT ALARM	ON
VLOSS ALARM	ON
KEY MUTE	YES
HDD OVERWRITE	YES
MESSAGE LATCH	YES
DATE DISPLAY	D/M/Y
DATE	26-DEC-2003 [FRI]
TIME	22:55:34
CLEAR HDD	YES
SYSTEM RESET	YES

## TIMER

### 1. DAY

Select the day, or days of the week (Mon-Fri / Sat-Sun / Daily) that you wish to schedule the DVR to automatically record.

NOTE :

1. Date could be changed by "+" and "-" buttons.
2. If you have selected the date and Timer recording set from that specific day to a new day, then the Timer Recording Schedule will be set as whole week.  
For specific date of Timer Recording Schedule, it is not recommended to set Ending Time over 23:59. For example: If you set Timer Schedule Day as Sunday, and START from 11:30, but End on 00:20, then Recording Timer Schedule is set as from every Sunday's 11:30 to next Sunday's 00:20. If you only want to set Recording Timer Schedule from every Sunday 11:30 to Monday 00:20, then you should set Recording Timer Schedule as Sunday from 11:30 to 23:59, and Monday from 00:00 to 00:20.
3. It is not suggested that users press "STOP" button or restart the system during setting time. In doing so, the recording will stop, and users can resume recording by pressing "ENTER" + "MENU".

(MENU)
TIMER
CAMERA
RECORD
ALARM
DWELL
PIP
DISPLAY
REMOTE
USER
SYSTEM
EVENT

## PLAY BACK

Press "PLAY" button, the DVR will show the last recording.

### 1. FAST FORWARD (F.F.) & FAST REWIND (F.R.)

You can increase the speed of Fast Forward and Rewind on the DVR.

In the Play mode, press "▶" once to get 2X speed forward and press twice to get 4X speed,... and the maximum speed can reach 32X.

Press "◀" once to get 1X speed rewind and press twice to get 2X speed, ... and the maximum speed can reach 32X.

### 2. SLOW FORWARD (S.F.) & SLOW REWIND (S.R.)

You can also slow down the speed of Forward and Rewind on the DVR.

In the Play mode, press the SLOW button and you will enter Slow mode.

Press "SLOW" once to get 1/2X speed forward and press "▶" to get 1/4X speed,... and the slowest speed can reach 1/32X.

Press "◀" once to get 1/2X speed rewind and press twice to get 1/4X speed, ... and the slowest speed can reach 1/32X.

### 3. PAUSE

You can pause the playback and the image will be displayed on the screen.

### 4. STOP

Press "STOP" button under any circumstance, DVR will return to live monitoring mode.

### 5. IMAGE JOG DIAL

It will allow you to manually view video frame-by-frame, one image at a time.

While in PLAY mode, press "PAUSE", it will pause the screen.

Press "▶" button advances the frozen screen one image forward.

Press "◀" button moves back one image.

Note: During the LIVE or PLAY mode, press "ENTER" + "SEARCH" buttons at the same time to switch the "NORMAL" and "SHARPNESS" display.

## CAMERA SELECT (1-4)

Press Camera Select (1-4) to select the camera to display in full screen.

## 2. START

Set the time to start the recording.

## 3. END

Set the time to end the recording.

## 4. IPS (IMAGE PER SECOND)

NTSC—30、15、8、4、2、1

PAL—25、12、6、3、2、1

## 5. QUALITY

Select the quality of recording image:

BEST, HIGH, NORM and BASE.

## 6. MODE

There are three recording mode settings :

QUAD-FRAME, QUAD-FIELD, MULTIPLEX.

NOTE: To select the appropriate recording mode before you start recording. We don't suggest to change the different recording mode during the recording to ensure the best recording quality.

## 7. TIMER ENABLE

When TIMER ENABLE is "YES", press "menu" button, you can see the timer diagram according to your setting.

(TIMER)						
DAY	START	END	IPS	QLT	MODE	
DAILY	01:00	22:00	30	BEST	Q-FR	
OFF	00:00	00:00	30	BEST	Q-FI	
OFF	00:00	00:00	30	BEST	Q-FI	
OFF	00:00	00:00	30	BEST	Q-FR	
OFF	00:00	00:00	30	BEST	Q-FR	
OFF	00:00	00:00	30	BEST	Q-FR	
OFF	00:00	00:00	30	BEST	MUX	
OFF	00:00	00:00	30	BEST	Q-FI	
TIMER ENABLE : YES						

1ST	00--05	06--11	12--17	18--23
MON	☒☒☒☒☒	☒☒☒☒☒	☒☒☒☒☒	☒☒☒☒☒
TUE	☒☒☒☒☒	☒☒☒☒☒	☒☒☒☒☒	☒☒☒☒☒
WED	☒☒☒☒☒	☒☒☒☒☒	☒☒☒☒☒	☒☒☒☒☒
THU	☒☒☒☒☒	☒☒☒☒☒	☒☒☒☒☒	☒☒☒☒☒
FRI	☒☒☒☒☒	☒☒☒☒☒	☒☒☒☒☒	☒☒☒☒☒
SAT	☒☒☒☒☒	☒☒☒☒☒	☒☒☒☒☒	☒☒☒☒☒
SUN	☒☒☒☒☒	☒☒☒☒☒	☒☒☒☒☒	☒☒☒☒☒
2ND	00--05	06--11	12--17	18--23
MON	☒☒☒☒☒	☒☒☒☒☒	☒☒☒☒☒	☒☒☒☒☒
TUE	☒☒☒☒☒	☒☒☒☒☒	☒☒☒☒☒	☒☒☒☒☒
WED	☒☒☒☒☒	☒☒☒☒☒	☒☒☒☒☒	☒☒☒☒☒
THU	☒☒☒☒☒	☒☒☒☒☒	☒☒☒☒☒	☒☒☒☒☒
FRI	☒☒☒☒☒	☒☒☒☒☒	☒☒☒☒☒	☒☒☒☒☒
SAT	☒☒☒☒☒	☒☒☒☒☒	☒☒☒☒☒	☒☒☒☒☒
SUN	☒☒☒☒☒	☒☒☒☒☒	☒☒☒☒☒	☒☒☒☒☒

# CAMERA

## 1. TITLE

Assign a title to each camera. Initially each title is the camera's number.

## 2. ALARM

Select LOW / OFF / HIGH for alarm polarity. The default value is LOW.

(CAMERA)						
TITLE	ALARM	REC	BR	CT	CL	HUE
CAMERA01	LOW	ON	18	15	15	18
CAMERA02	OFF	OFF	18	15	15	18
CAMERA03	HIGH	OFF	18	15	15	18
CAMERA04	HIGH	ON	18	15	15	18

(MENU)
TIMER
<b>CAMERA</b>
RECORD
ALARM
DWELL
PIP
DISPLAY
REMOTE
USER
SYSTEM
EVENT

### 3. REC (RECORD)

Set up which channel you want to record.

ON : when alarm input is triggered, DVR will record alarming channel more frequently.

For example : when CH01 is triggered, the record method will become 1-2-1-3-1-4....

OFF : DVR will not record.

### 4. BR (BRIGHTNESS)

Adjust the brightness of each channel. The level is from 0 to 63.

### 5. CT (CONTRAST)

Adjust the contrast of each channel. The level is from 0 to 63.

### 6. CL (COLOR)

Adjust the color of each channel. The level is from 0 to 63.

### 7. HUE (HUE)

Adjust the hue of each channel. The level is from 0 to 63.

(MENU)
TIMER
CAMERA
<b>RECORD</b>
ALARM
DWELL
PIP
DISPLAY
REMOTE
USER
SYSTEM
EVENT

## RECORD

### 1. RECORD IPS

Select the recording speed. The options are as following :

NTSC—30、15、8、4、2、1

PAL—25、12、6、3、2、1

(RECORD)
<b>RECORD IPS</b> 30
QUALITY NORMAL
RECORD MODE QUAD-FRAME

### 2. QUALITY

There are four quality settings : BASIC, BEST, HIGH, NORMAL.

NOTE : The relationship of Record time, IPS and Record quality, please refer to page.23 Recording Speed.

### 3. RECORD MODE

There are three recording settings : QUAD-FRAME, QUAD-FIELD, MULTIPLEX.

NOTE: To select the appropriate recording mode before you start recording. We don't suggest to change the different recording mode during the recording to ensure the best recording quality.

(MENU)
TIMER
CAMERA
RECORD
<b>ALARM</b>
DWELL
PIP
DISPLAY
REMOTE
USER
SYSTEM
EVENT

## ALARM

### 1. ALARM ENABLE

Alarm will be triggered by event occurrence when the setting is YES.

### 2. ALARM DURATION

Set the reaction time which was determined by how long the alarm mode responded to a buzzer. Default setting is 10 Sec. Options are 10 Sec, 15 Sec, 20 Sec, 30 Sec, 1 MIN, 2 MIN, 3 MIN, 5 MIN, 10 MIN, 15 MIN, 30 MIN, ALWAYS, AUTO.

NOTE : 1. Video loss and Alarm will be shown the same as Alarm Duration time.  
2. When the setting is AUTO, the alarm duration time is according to the setting of the external alarm device.

3. During ALARM DURATION'S setting time, users can restart ALARM function by pressing both "ENTER" + "STOP" buttons.

(ALARM)
<b>ALARM ENABLE</b> YES
ALARM DURATION 15 MIN
RECORD IPS 30
QUALITY NORMAL
RECORD MODE QUAD-FRAME

### 3. REC IPS

Select the images per second of recording during an ALARM. The options are as following:  
NTSC—30、15、8、4、2、1  
PAL—25、12、6、3、2、1

### 4. QUALITY

There are four quality settings during an ALARM : BASIC, BEST, HIGH, NORMAL.

### 5. RECORD MODE

There are three recording settings : QUAD-FRAME, QUAD-FIELD, MULTIPLEX.

## DWELL

#### 1. NORM

To set up the DWELL time period that each channel auto sequentially shows on call monitor. The level is from 1 to 15 Sec or OFF.

#### 2. ALARM

To set up the DWELL time period when alarm input is triggered. The level is from 1 to 15 Sec or OFF.

	(DWELL)	
	NORM	ALARM
CAM1	01	01
CAM2	01	01
CAM3	01	01
CAM4	01	01

(MENU)
TIMER
CAMERA
RECORD
ALARM
<b>DWELL</b>
PIP
DISPLAY
REMOTE
USER
SYSTEM
EVENT

## PIP

#### 1. FULL SCREEN

To set up the full screen background picture display.

#### 2. PIP SCREEN

To set up the picture with a 1/9 size screen “insert”.

#### 3. POSITION

There are six position settings : D/L, D/M, D/R, U/L, U/M, U/R.

	(PIP)	
FULL SCREEN	CAM 1	
PIP SCREEN	CAM 2	
POSITION	D/R	

(MENU)
TIMER
CAMERA
RECORD
ALARM
DWELL
<b>PIP</b>
DISPLAY
REMOTE
USER
SYSTEM
EVENT

## DISPLAY

#### 1. TITLE DISPLAY

To set the title shown on monitor or not.

#### 2. OSD COLOR

Select the OSD (On Screen Display) color. The options are YELLOW, GREEN, CYAN, BLUE, PINK, GRAY, WHITE, RED.

(MENU)
TIMER
CAMERA
RECORD
ALARM
DWELL
PIP
<b>DISPLAY</b>
REMOTE
USER
SYSTEM
EVENT

### 3. LOSS SCREEN

Retain the last picture or select the LOSS SCREEN color.  
The options are GREEN, BLACK, BLUE and RETAIN.

### 4. TIME POSITION

To set the OSD POSITION shown on monitor.  
The options are NORMAL or CENTER.

(DISPLAY)	
TITLE DISPLAY	YES
OSD COLOR	YELLOW
LOSS SCREEN	GREEN
TIME POSITION	NORMAL

## REMOTE

### 1. REMOTE MODE

Set the remote mode for connection with computer via RS-232 or RS-485.  
(Please refer to page. 21& 22 for RS-232& RS-485 Remote Control).

### 2. BAUD RATE

Set the remote protocol transmitting baud rate. Available options are 115200, 57600, 19200, 9600, 4800, 3600, 2400, 1200.

### 3. ID

To control different DVR by setting remote protocol. ID number can be set from 000 to 255.

(REMOTE)	
REMOTE MODE	RS-485
BAUD RATE	9600
ID	255

(MENU)	
TIMER	
CAMERA	
RECORD	
ALARM	
DWELL	
PIP	
DISPLAY	
REMOTE	
USER	
SYSTEM	
EVENT	

## USER

### 1. USER

To set up the user account for controlling. It allows 8 users setting.

Supervisor – Control all the functions.

Other Users – View all functions except the menu setting and event list cleaning.

### 2. PASSWORD

To set the security password for each account.  
The maximum length of user's password is 4 characters.

NOTE: To switch to different USER, press "ENTER"  
+ "MENU" buttons to "KEY LOCK" and then enter the different user's password to UNLOCK.

(MENU)	
TIMER	
CAMERA	
RECORD	
ALARM	
DWELL	
PIP	
DISPLAY	
REMOTE	
USER	
SYSTEM	
EVENT	

(USER)	
PASSWORD	
SUPERVISOR	0000
USER 1	0000
USER 2	0000
USER 3	0000
USER 4	0000
USER 5	0000
USER 6	0000
USER 7	0000

## EVENT

A single page can display 16 recorded events. Press “◀” or “▶” to change the pages or press “▲” + “▼” to CLEAR the EVENT record.

DISK FULL: HDD is full

PWR REST : Power restored

M-HD REMS: HDD remove

M-HD REPL: HDD replace

M-HD ERR : HDD error

M-HD WARM: HDD warning

K UNLOCKS: Key is unlock

DMA ERROR: DMA error

C1 VLOSS : Channel 1 is video loss

C2 ALARM : Channel 2 has been triggered by external I/O alarm

SYSTEM ERROR: System might fail

POWER RESTORE : Power restored

(MENU)  
TIMER  
CAMERA  
RECORD  
ALARM  
DWELL  
PIP  
DISPLAY  
REMOTE  
USER  
SYSTEM  
EVENT

C1 VLOSS	26-DEC-2002	03:00:00
C2 ALARM	26-DEC-2002	03:00:00
K UNLOCKS	26-DEC-2002	03:00:00
M-HD ERR	26-DEC-2002	03:00:00
M-HD WARM	26-DEC-2002	03:00:00
PWR REST	26-DEC-2002	03:00:00
DMA ERROR	26-DEC-2002	03:00:00
M-HD REPL	26-DEC-2002	03:00:00

↑ + ↓ : CLEAR

## OPERATION OPTIONS

## Advanced Operation

### VIDEO LOSS

Screen will display “LOSS” in the center of display picture, if the video input is not connected properly.

### SEARCH

#### 1. LAST RECORD

Play the last recorded piece of video.

#### 2. FULL LIST

List all recorded video on the HDD which sorted by time.

 : Manual Recording

 : Alarm Recording

 : Timer Recording

M : Storage in Master HDD (or S:Storage in Slave HDD)

S : Storage in Slave HDD

NOTE: It will display different color on each record list mention above.

#### 3. ALARM LIST







List all recorded video triggered by an Alarm.

NOTE : If there are no Alarm in the record, the screen will display “EMPTY”.

#### 4. TIME SEARCH

Find video recorded on a specific date that is entered.

LAST RECORD  
FULL LIST  
ALARM LIST  
TIME SEARCH

	2003-JAN-01	01:02:03	M
	2003-JAN-05	05:02:03	M
	2003-MAR-12	04:02:03	M
	2003-APR-02	03:02:04	M
	2003-MAY-01	05:02:03	M
	2003-AUG-09	01:02:01	M

← : PAGE UP → : PAGE DOWN

## KEY LOCK

For advanced security, you can “Lock” the buttons on your DVR. Key-Lock prevents other people from using the system.

Press ENTER and MENU at the same time to enable Key Lock.

Press ENTER and MENU at the same time and key in password (Default : 0000), then press “ENTER” to disable Key Lock.

NOTE: To switch to different USER, press “ENTER” + “MENU” buttons to “KEY LOCK” and then enter the different user’s password to UNLOCK.

## RS-232 REMOTE PROTOCOL

You can use the PC keyboard to simulate DVR keypad.

DATA: REMOTE PROTOCOL using 8 bit data · 1 start bit · 1 stop bit

FUNCTION	CODE	ASCII	FUNCTION	CODE	ASCII
KEY_MENU	0x4D	M	KEY_PLAY	0x50	P
KEY_SEARCH	0x73	s	KEY_DOWN	0x4E	N
KEY_ENTER	0x0D	ENTER	KEY_RIGHT	0x52	R
KEY_QUAD	0x51	Q	KEY_POWER	0x57	W
KEY_POP	0x5A	Z	KEY_KEY_LOCK	0x4B	K
KEY_PIP	0x70	p	KEY_CH1	0x31	1
KEY_SLOW	0x53	S	KEY_CH2	0x32	2
KEY_REC	0x72	r	KEY_CH3	0x33	3
KEY_LEFT	0x4C	L	KEY_CH4	0x34	4
KEY_UP	0x55	U	TIMER REC PROCEED	0X54	T

## TROUBLESHOOTING

When malfunction occurs, it may be not serious and can be corrected easily. The table below describes some typical problems and their solutions. Please check them before calling your DVR dealer.

PROBLEM	SOLUTION
No power	<ul style="list-style-type: none"> <li>I Check power cord connections.</li> <li>I Confirm that there is power at the outlet.</li> </ul>
Not working when press any button	<ul style="list-style-type: none"> <li>I Check if it is under Key Lock mode.</li> <li>I Press "<b>MENU</b>" &amp; "<b>ENTER</b>" to exist Key Lock mode.</li> </ul>
No recorded video	<ul style="list-style-type: none"> <li>I Check if the HDD is installed properly.</li> </ul>
Timer Record enable does not working	<ul style="list-style-type: none"> <li>I Check if the Record Enable is set to YES</li> </ul>
No live video	<ul style="list-style-type: none"> <li>I Check camera video cable and connections.</li> <li>I Check monitor video cable and connections.</li> <li>I Confirm that the camera has power.</li> <li>I Check camera lens setting.</li> </ul>
NTSC & PAL System switch	To switch the system, press “POWER” + “FF” to NTSC system and “POWER” + “REW” to PAL system. (Refer to Page 8 "Getting Started".)

# SPECIFICATIONS

<b>Video format</b>	NTSC/EIA or PAL/CCIR
<b>Hard disk storage</b>	IDE type, UDMA 66, supported 250 GB HDD
<b>Recording mode</b>	Manual / Alarm / Timer
<b>Camera Input Signal</b>	Composite video signal 1 Vp-p 75 $\Omega$ BNC, 4 channels
<b>Main Monitor Output</b>	Composite video signal 1 Vp-p 75 $\Omega$ BNC
<b>Call Monitor Output</b>	Composite video signal 1 Vp-p 75 $\Omega$ BNC
<b>Video Loss Detection</b>	Yes
<b>Refresh Rate</b>	Up to 240 fields/sec. <NTSC> / 200 fields/sec. <PAL>
<b>Recording Rate</b>	Multiplex: Up to 30 fields/sec.<NTSC> / 25 fields/sec. <PAL> Quad-field: Up to 120 fields/sec. <NTSC> / 100 fields/sec. <PAL> * Quad-frame: Up to 240 fields/sec. <NTSC> / 200 fields/sec. <PAL>**
<b>Dwell Time</b>	Programmable (1~15 Sec)
<b>Picture in Picture</b>	Yes (Movable)
<b>Key Lock</b>	Yes
<b>Camera Title</b>	8 letters
<b>Video Adjustable</b>	Hue/ Color/ Contrast/ Brightness Adjustable
<b>Alarm Input</b>	TTL input, Hi (5V), Low (GND)
<b>Alarm Output</b>	COM./N.O/N.C
<b>Remote Control</b>	RS-232 or RS-485
<b>Time Display Format</b>	YY/MM/DD, DD/MM/YY, MM/DD/YY, OFF
<b>Power Source</b>	DC 19V
<b>Power Consumption</b>	<32W
<b>Operation Temperature</b>	10 ~ 40 $^{\circ}$ C
<b>RS-232C / RS-485 (bps)</b>	115200、57600、19200、9600、4800、3600、2400、1200
<b>Dimension (mm)</b>	343(W) x 223(L) x 59(H)
<b>Net Weight</b>	1.5 kgs

• Specifications are subject to change without notice.

\*NTSC: 4CH x 30IPS = 120 fields/sec, PAL: 4CH x 25IPS = 100 fields/sec

\*\*NTSC: 4CH x 60IPS = 240 fields/sec, PAL: 4CH x 50IPS= 200 fields/sec

# APPENDIX #1 – INSTALL THE HDD

Follow the steps carefully in order to ensure correct installation.

The compartment located on the front panel of the DVR is the removable Cartridge, in which you insert the HDD. The various parts of the Cartridge are labeled for your reference.

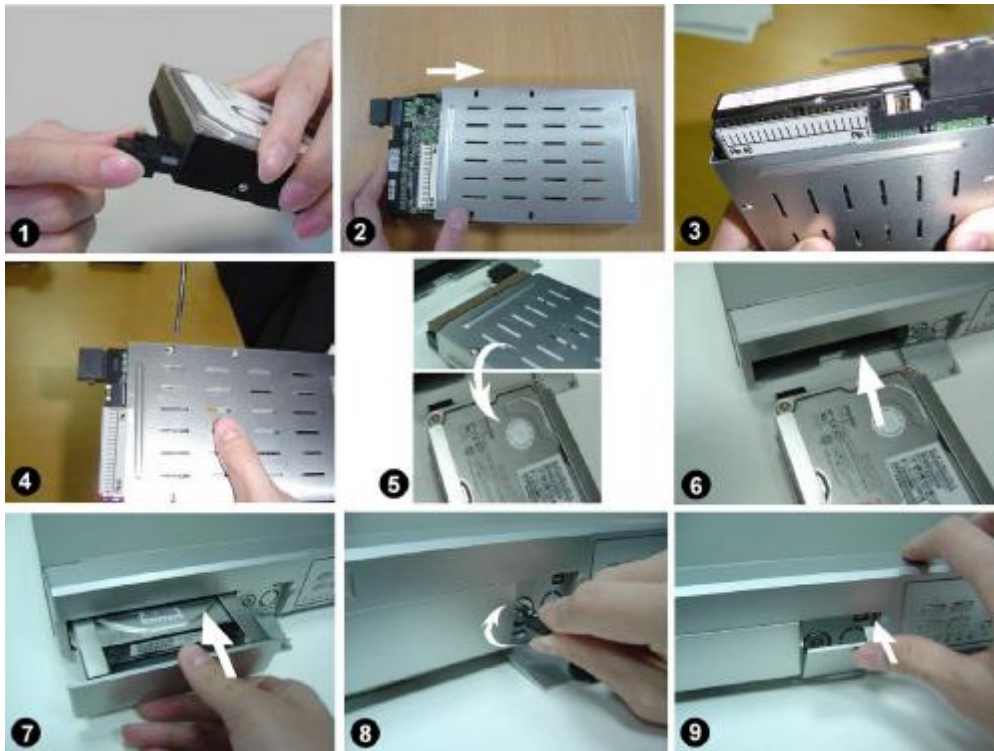

Step 1 Connect the connector with the HDD (refer to Picture 1).

Step 2 Put HDD into the HDD cartridge. Please notice the bottom side is power side as chart shows (refer to Picture 2).

Step 3 Screw the HDD to the cartridge. Before you screw the HDD, please be aware that you must level pin 1 of the HDD at pin 1 mark of the label, because the screw hole is different from different HDD brands. Then screw the HDD correctly (refer to Picture 3 and 4). You must precisely align the hard disk to the pin connect to ensure correct installation.

Step 4 Reverse the HDD and put it into DVR (refer to Picture 5 and 6).

Step 5 Connect the HDD with DVR (refer to Picture 7).

Step 6 Lock the cabinet by turning the key clockwise (refer to Picture 8).

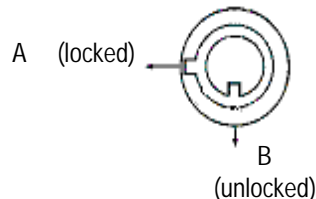

Note : If you do not lock the cabinet, the DVR system will not function properly.

Step 7 Close the cap (refer to Picture 9).

Note: **Do not try to retrieve the HDD data by PC. The video file cannot be read by PC, operation on PC would damage the FAT table of the hard disk.**

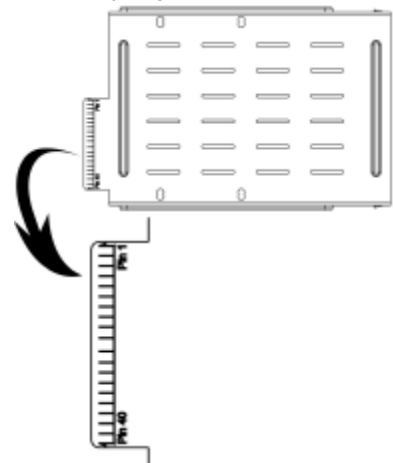

## APPENDIX #2 – REPLACE THE HDD



Step 1 Open the cap



Step 3 Pull out the cartridge



Step 2 Unlock the cabinet by turning the key anti-clockwise



Step 4 Loose all screws on the Cartridge

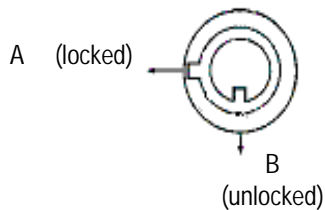

Step 5 Remove the HDD from Cartridge

Note: 1. If you want to change the different HDD, you must remove the connector from HDD (refer to Page 19).

2. When HDD works for a period of time, the surface temperature will be high, please notice it.

### HDD HOT SWAP FUNCTION

Please must follow the steps as following to ensure the reliability.

- 1)Unlock the cabinet by turning the key anti-clockwise.
- 2)Key in your password and press enter to disable the hard drive.
- 3)Pull out the HDD cartridge.
- 4)Replace the HDD in the tray.

Note: After turning the key to unlock position, please wait for several seconds till HDD operation stop completely.

# APPENDIX #3 – PIN CONFIGURATIONS

## 15 pin com port

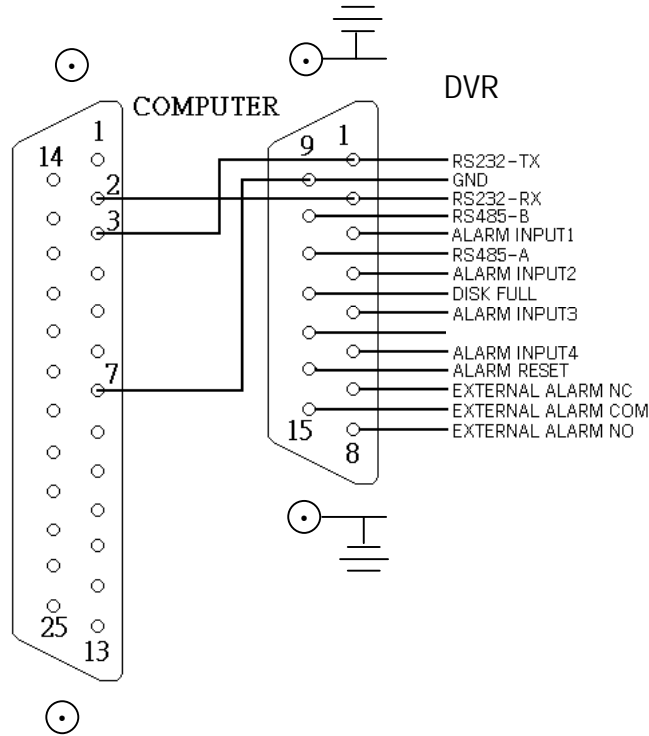

## 9 pin com port

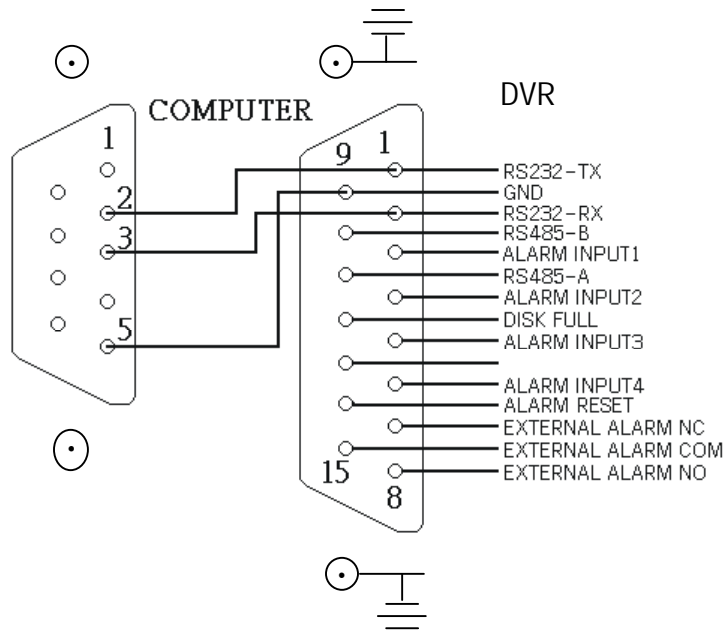

#### **PIN 1. RS232-TX : RS-232**

DVR can be controlled remotely by an external device or control system, such as a control keyboard, using RS-232 serial communications signals.

#### **PIN 2. RS232-RX : RS-232**

DVR can be controlled remotely by an external device or control system, such as a control keyboard, using RS-232 serial communications signals.

#### **PIN 3, 4, 5, 6 ALARM INPUT**

To connect wire from ALARM INPUT (PIN 3, 4, 5, 6) to GND ( PIN 9 ) connector, DVR will start recording and buzzer will be on. When alarm has been triggered, signal becomes "Low", and it will stop all alarm activities. Under normal operation, signal remains "High".

#### **PIN 7. EXTERNAL ALARM NC**

Under normal operation COM connect with NC and disconnect with NO. But when alarm triggered, COM disconnect with NC, and connect with NO.

#### **PIN 8. EXTERNAL ALARM NO**

Under normal operation, COM will disconnect from NO. But when Alarm triggered, COM will connect with NO.

#### **PIN 9. GND**

GROUND

#### **PIN 10. RS485-B**

DVR can be controlled remotely by an external device or control system, such as a control keyboard, using RS485 serial communications signals.

#### **PIN 11. RS485-A**

DVR can be controlled remotely by an external device or control system, such as a control keyboard, using RS485 serial communications signals.

#### **PIN 12. DISK FULL (OUTPUT)**

When HDD is full, it sends a signal to trigger next DVR record mode, if you install another DVR. Under normal operation, the signal remains "High". But when disk full, DVR will send the "Low" signal.

#### **PIN 14. ALARM RESET (INPUT)**

To connect wire from ALARM RESET ( PIN 14 ) to GND ( PIN 9 ) connector, it can disable ALARM. An external signal to ALARM RESET ( PIN 14 ) can be used to reset both ALARM OUTPUT signal and DVR's internal buzzer. When alarm has been triggered, signal becomes "Low", and it will stop all alarm activities. Under normal operation, signal remains "High".

#### **PIN 15. EXTERNAL ALARM COM**

Under normal operation COM connect with NC and disconnect with NO. But when alarm triggered, COM disconnect with NC, and connect with NO.

## APPENDIX #4 – RECORDING SPEED

The Record Time is different based on Recording Speed, Recording Quality and Recording Mode. Please refer to following table. The HDD capability is 250GB.

NTSC SYSTEM		IPS	30	15	8	4	2	1
MULTIPLEX	Best	50hr	100hr	187hr	375hr	750hr	1500hr	
	High	62hr	125hr	235hr	468hr	937hr	1875hr	
	Normal	100hr	200hr	375hr	750hr	1500hr	2998hr	
	Basic	167hr	333hr	625hr	1250hr	2498hr	4996hr	
QUAD-FIELD	Best	48hr	95hr	178hr	356hr	712hr	1425hr	
	High	59hr	118hr	223hr	445hr	890hr	1781hr	
	Normal	95hr	190hr	356hr	712hr	1425hr	2848hr	
	Basic	158hr	316hr	594hr	1187hr	2373hr	4746hr	
QUAD-FRAME	Best	24hr	48hr	89hr	178hr	356hr	713hr	
	High	30hr	59hr	112hr	223hr	445hr	890hr	
	Normal	48hr	95hr	178hr	356hr	713hr	1424hr	
	Basic	79hr	158hr	297hr	594hr	1187hr	2373hr	
HDD Type	250 GB							

PAL SYSTEM		IPS	25	12	6	3	2	1
MULTIPLEX	Best	50hr	104hr	210hr	423hr	633hr	1266hr	
	High	62hr	131hr	265hr	527hr	792hr	1583hr	
	Normal	102hr	210hr	422hr	844hr	1266hr	2542hr	
	Basic	168hr	350hr	704hr	1406hr	2110hr	4218hr	
QUAD-FIELD	Best	48hr	98hr	200hr	400hr	600hr	1202hr	
	High	58hr	124hr	251hr	500hr	752hr	1503hr	
	Normal	98hr	200hr	400hr	800hr	1202hr	2414hr	
	Basic	160hr	332hr	668hr	1335hr	2004hr	4005hr	
QUAD-FRAME	Best	24hr	50hr	100hr	200hr	300hr	600hr	
	High	30hr	62hr	125hr	250hr	376hr	751hr	
	Normal	49hr	100hr	200hr	400hr	601hr	1207hr	
	Basic	80hr	166hr	334hr	667hr	1002hr	2003hr	
HDD Type	250 GB							

Note: Above data is obtained from actual test of recording normal TV program. (For Reference Only)

# APPENDIX #5 – NETWORK APPLICATION

## Video Web Server Features

- Compatible with most of CCTV Products; empower any video output device watching and controlling on the Internet or LAN
- Auto Network Reconnection (ANR)
- Upgrade firmware & AP from FTP site via Video Web Server
- Watch dog function supported
- Support Dynamic IP address
- 4 alarm inputs supported
- Duplex function, record and playback simultaneously at client site
- Auto e-mail warning system which will remind you if external alarm happened
- Intelligent non-stoppable recording function after ANR
- Multi AP screens supported
- Unique video player



Video Web Server

## DVR Control

- 1) Connect the Sub-D plug of Video Web Server with our own brand DVR products.

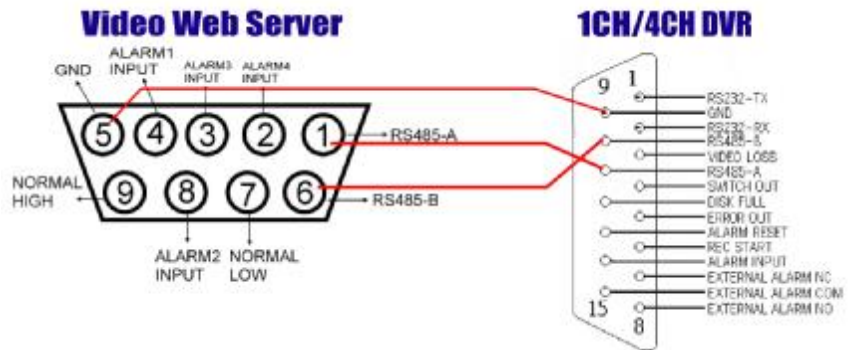

- 2) Set the "Remote" function in the DVR products.

NOTE : Remote mode : RS-485,  
Baud rate : 2400, ID : same  
as "I/O port setting" in the Video  
Web Server.

### 1/4 CH DVR

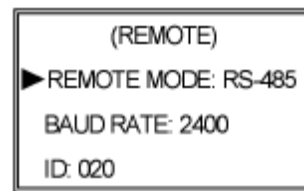

- 3) Set the "I/O Port Setting" in the system config of Video Web Server.  
Port1 : DMR-4, Device ID : 20.

